

NEWPOCKET

Side Loading Casepacker

FLEXIBILITY IN CASE PACKAGING

Newpocket is a servo driven side loading casepacker with a wide choice in packaging style: boxes, trays or cases. This machine is available also in a tray version, equipped with a system to handle die cut trays from flats.

- Short footprint
- American and/or pressed type cartons handling
- Final quality inspection device
- High performance
- Speed up to 25 cycles/minute

NEWPOCKET

Side Loading Casepacker



TECHNICAL DATA

Max mechanical speed	up to 25 cycles/minute
Max compressed air consumption	5+6 NL/cycles
Working pressure	6 BAR
Max absorbed power:	
with adhesive tape closure	3,5 kW
with hot-melt closure	6 kW
Weight of basic machine	2.000 Kg

SIZE RANGE

Measures in mm.
Modifications can be made for sizes exceeding the standard limit.

TRAY

	A	B	C
min.	80	40	70
max	300	100	350

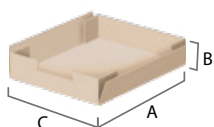

CASE (internal dimension)

	A	B	C
min.	150	130	105
max	450	290	350

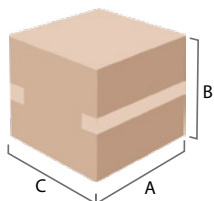

LAYOUT

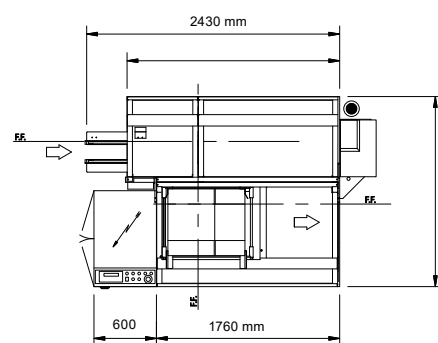
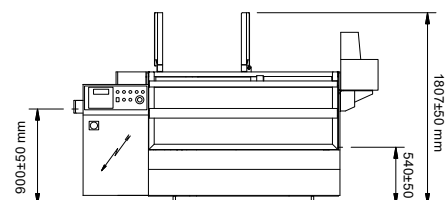

INFEED

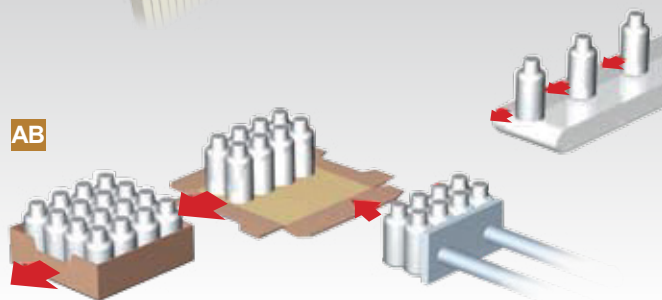
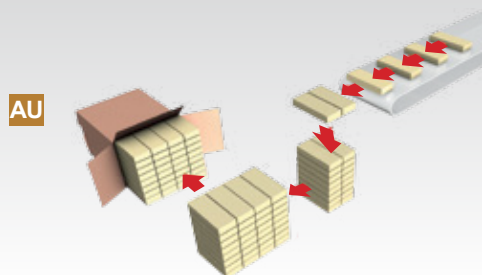
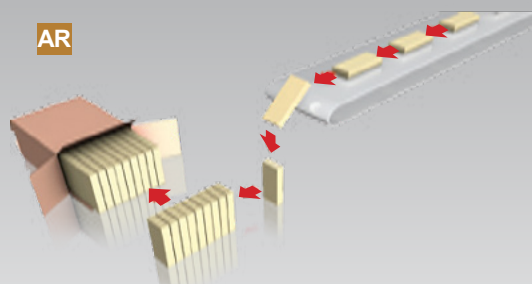
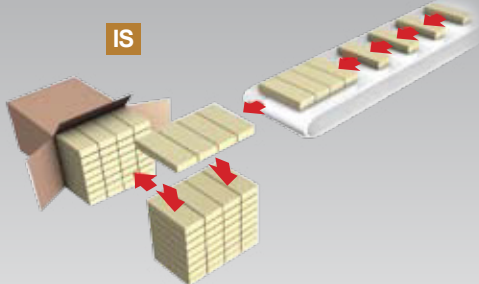

PIERREBI machines comply european standard for work safety (CE mark), and they are supplied with detailed technical informations. Technical data and illustrations are not binding; PIERREBI reserves the right to change the specifications of its machines at any time.

PIERREBI SRL

Via Dell'Artigianato,31 - 48014 Castel Bolognese (RA) - Italy
Tel. +39 0546 656131 - pierrebi@pierrebi.it

